

Installation instructions

Roger Dynamic SoundField

The following materials are included (if any are missing, contact your local Phonak dealer):

Roger DigiMaster package

A

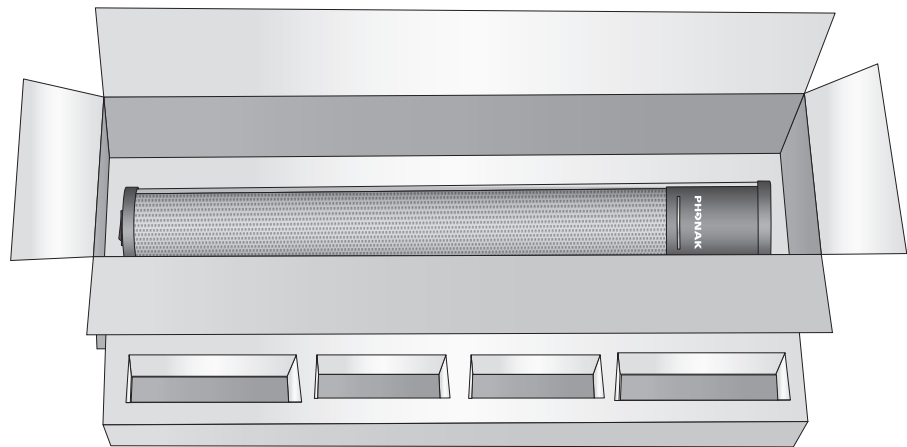
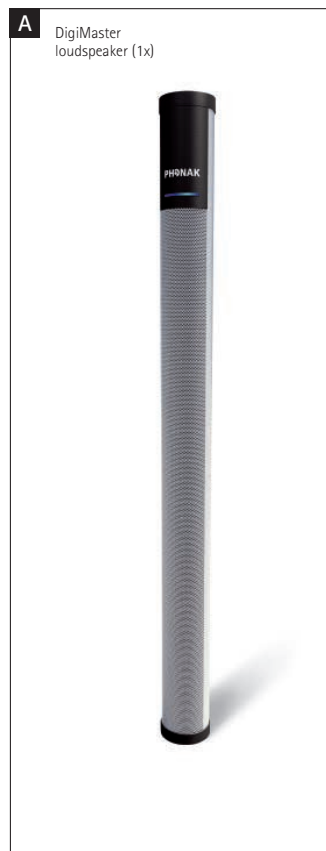

Follow these installation instructions carefully to make sure your Phonak Dynamic SoundField system is properly installed.



Dispose of the packaging material as per local regulations.

Optional: Standard 'DigiMaster Floor Stand' including:

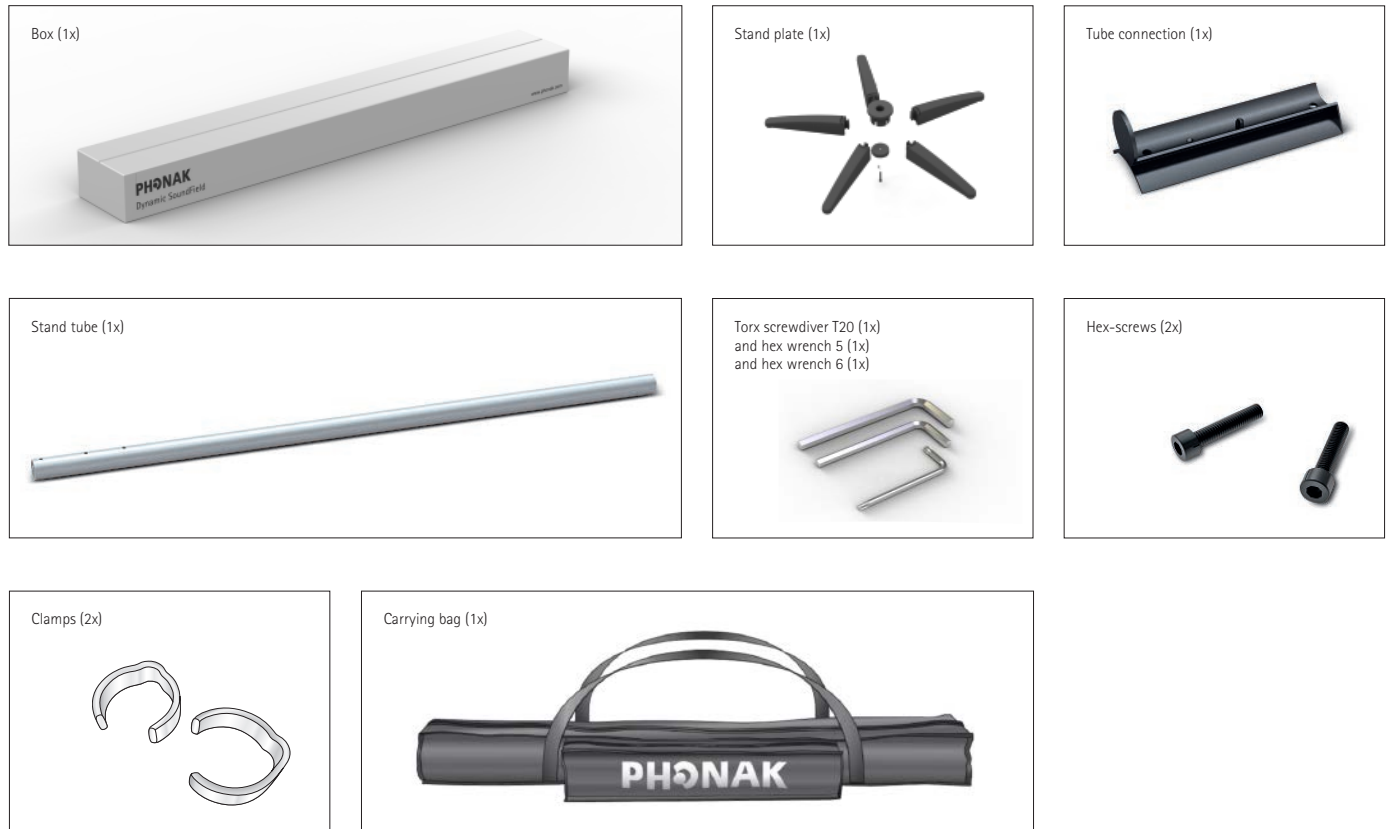

Optional: Wall Mount kit including

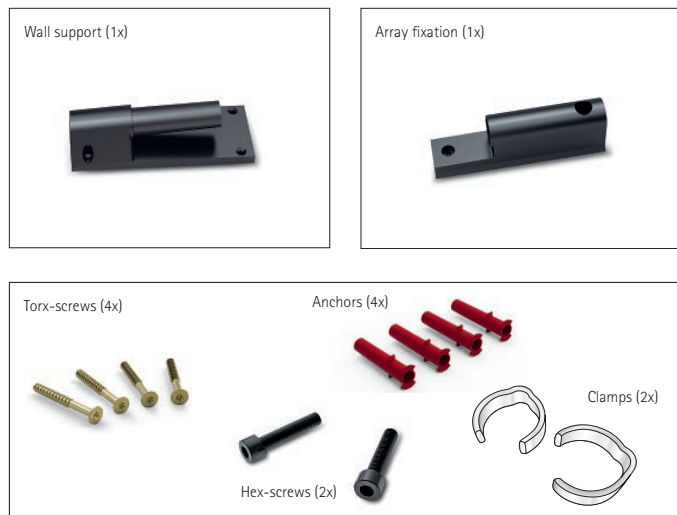

Installation instructions

Roger Dynamic SoundField

The following tools are required for the installation:

To mount the loudspeaker on the floor stand:

- Hex wrench 5
- Hex wrench 6

To mount the loudspeaker on the wall:

- Drill with 5mm bit
- Spirit level
- Pencil
- Torx screwdriver T20
- Hex wrench 5

1. Selecting the right location

- 1) Identify an open and safe place, ideally in front of the class, e. g. on the right or left side of the whiteboard or blackboard.

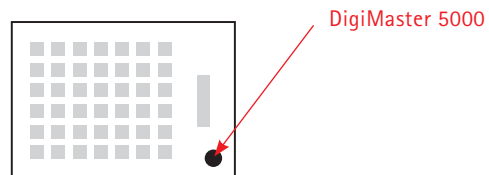

Option 1

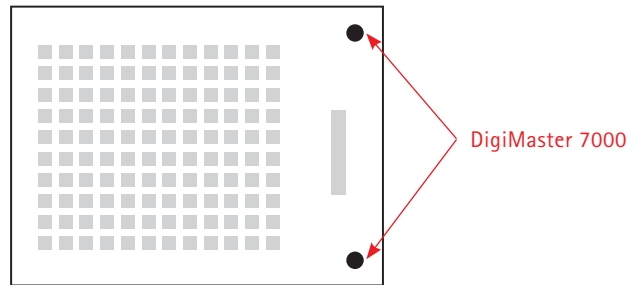

Option 2

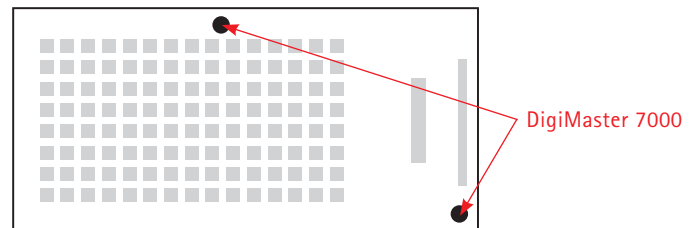

2. Installation

2.1 Mounting the DigiMaster Floor Stand

Follow the instructions delivered in the DigiMaster Floor Stand packaging.

2.2 Mounting DigiMaster on the wall

- 1) Measure 1.40 meters (4 feet) up from floor level and mark this point on the wall with a pencil.
Hold the wall support against the wall so that the pencil mark is at the bottom of the wall support. Adjust the wall support using the spirit level until it is level. Use the pencil to mark the wall through the wall support's four holes.

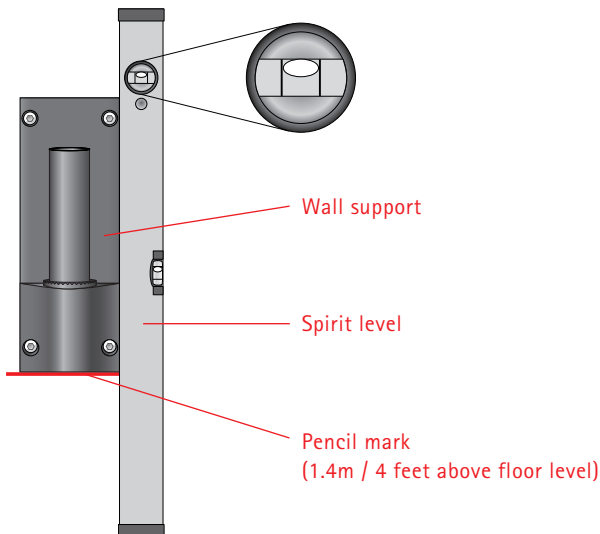

- 2) Remove the wall support and drill 4 holes using a 5 mm (0.2 inch) diameter drill bit. The depth of these holes should be at least 30 mm (1.2 inches).

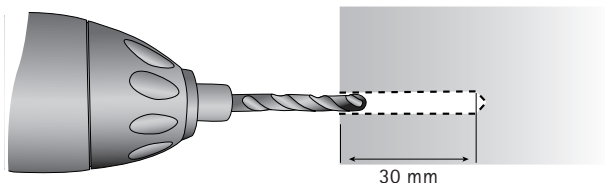

- 3) Push the anchors into the holes. Mount the wall support using the 4 torx screws and the torx T20 screwdriver.

- 4) Mount the array fixation on the DigiMaster by using the two black hex screws and hex wrench 5.



- 5) Carefully attach the DigiMaster [A] to the wall support and turn it to face the center of the class.

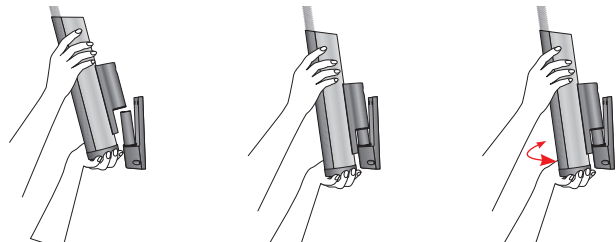

- 6) Attach the power cable to the power adapter. Plug the power cable into the mains and the 19 Volt jack into the socket on the bottom of the DigiMaster. Your DigiMaster is now ready to be paired with the inspiro.

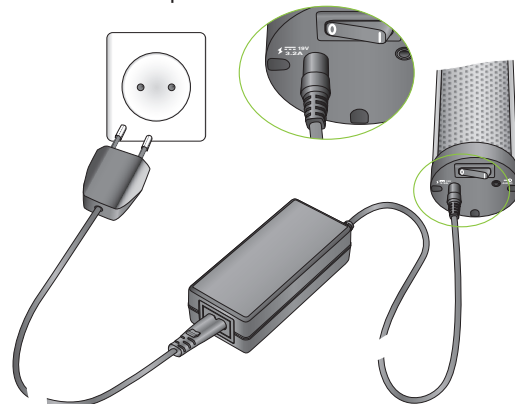

Make sure the power cable is safely positioned!



Please check the Phonak SoundField User Guide to learn about the standard functions of Phonak SoundField.

2.3 How to upgrade the DigiMaster?

- 1) Connect the USB cable to the DigiMaster's mini-USB jack on the top of the loudspeaker, as depicted below.
- 2) Connect the cable to computer running Roger Upgrader software.
- 3) Follow the instructions displayed on the computer screen.

